



INSTALLATION INSTRUCTIONS FOR KINETROL ISO ADAPTORS

1. INTRODUCTION

ISO adaptor kits are designed for converting a standard male drive Kinetrol actuator (double or single acting) to a mounting compliant with ISO 5211:2001. They are available in sizes 02, 03, 05, 07, 08 and 09, and can be fitted to the spring unit of size 02.

2. MATERIALS OF CONSTRUCTION

	MATERIAL	FINISH
ISO adaptor body:	Iizro zinc alloy OR Aluminium alloy	Epoxy Stove Enamel
Coupling (other materials may be available on request)	Low carbon steel	Zinc plate & passivated
Fixing Screws	High strength steel or stainless steel	Zinc plate or natural

3. PRINCIPAL DIMENSIONS

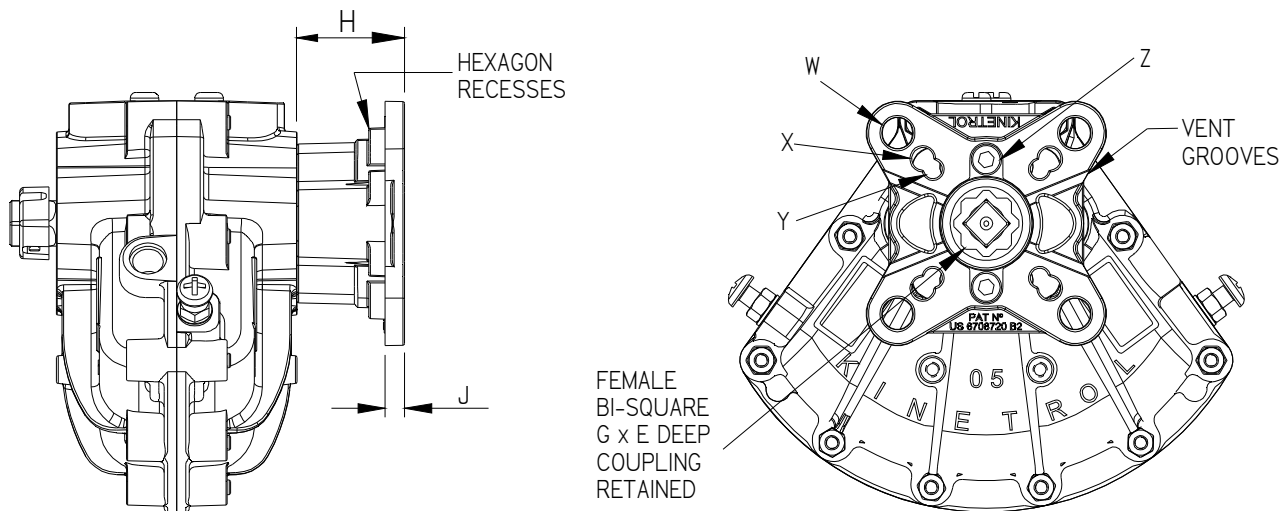

Adaptor Kit	Sales codes Assy.	ISO flange Sizes	H mm	J mm	G mm	E mm	ØW mm	PCD mm	ØX mm	PCD mm	ØY mm	PCD mm	Wt. kg.
SP1406	023F120/ 023F100	F03/F05	24	5	11	12	6.6	50	5.5	36	-	-	0.13
SP1407	023F180/ (024-100Z + SP1407)	F04	24	5	11	12	5.5	42	-	-	-	-	0.13
SP1449	033F100	F03/F05	24	5	11	12	6.6	50	5.5	36	-	-	0.13
SP1454	034-100Z + SP1454	F04	24	5	11	12	5.5	42	-	-	-	-	0.13
SP1339	053F100	F04/F05/F07	30	5.4	14	17	9.0	70	6.6	50	5.5	42	0.18
SP1498	054-100Z + SP1498	F04/F05	30	5.4	14	17	-	-	6.6	50	5.5	42	0.17
SP1451	073F100	F05/F07	40	8	17	19	9.0	70	6.6	50	-	-	0.53
SP1445	083F100	F07/F10	50	10	22	24	11.0	102	9.0	70	-	-	1.04
SP1452	093F100	F07/F10	50	10	22	24	11.0	102	9.0	70	-	-	1.04



INSTALLATION INSTRUCTIONS FOR KINETROL ISO ADAPTORS

4. FITTING TO ACTUATOR

The coupling is retained by the ISO adaptor and therefore must be fitted to the actuator male square first. The ISO adaptor body locates on male pegs which fit into corresponding holes in the actuator mounting face. The ISO adaptor is retained by 2 or 4 high tensile screws (Z). These should be fitted with a low strength retainer such as Loctite 222 and tightened to the torque given in the chart below:

	Screw size (Z)	No. Off	Recommended Tightening Torque	
			Nm	(lbf.ins)
SP 1406/1407	M4 x 12	4	2.4	(20)
SP 1449/1454	M4 x 12	4	2.8	(25)
SP 1339/1498	M8 x 12	2	15	(132)
SP 1451	M8 x 25	2	28	(250)
SP 1445	M8 x 25	2	28	(250)
SP 1452	M8 x 25	2	28	(250)

5. FITTING TO VALVE OR OTHER LOAD

There are multiple sets of mounting holes available in the mounting flange as shown in section (3). The actuator side of the mounting face contains hexagon recesses suitable for fitting standard metric nuts. Screws can be fitted through the mounting flange or bracket into these nuts and tightened as normal. Socket head cap screws can also be fitted the other way round so that the mounting screws can be fixed into tapped holes in the valve mounting flange. In order to tighten screws fitted this way, a "shortened" allen key will be needed.

The connecting coupling contains a bi-square that can be reduced down using inserts in order that it fits on to the stem of the valve.

Do not apply end loading to this product. It is also advisable to ensure that the ISO adaptor is fitted concentrically to the valve/load in order to avoid excessive side loads.

NOTE: Ensure that materials and finishes are suitable for the environment in which they are to be used. If unsure, contact Kinetrol Ltd.

6. 02 SPRING RETURN OPTION

The ISO adaptor (SP1406/SP1407) can be fitted to the 02 spring return in the same way as an 03 ISO adaptor (SP1449/SP1454). To achieve the correct alignment of the flange mounting holes to the square output and handle, a keeper plate must be fitted to the spring mounting flange and the screws between the spring housing and base plate removed and refitted into the alternative mounting holes available at 15° and re-tightened with thread adhesive.

NOTE : ALL REFERENCES IN THIS DOCUMENT ARE CORRECT AT DATE OF ISSUE.
FOR OLDER MODELS, OR IF IN DOUBT, CONTACT KINETROL.